

SC

STANDARD SERIES

MATERIALS

SC31 & SC41
Cover & head: Aluminium alloy
Bowl: Polyamide

SC71 & SC81
Cover & housing: Aluminium

Shut-off valve:
Polyamide

Seals:
NBR Nitrile
(FKM - on request fluoroelastomer)

Indicator housing:
Brass

PRESSURE (ISO 10771-1:2002)

Collapse, differential
for the filter element (ISO 2941):
100 kPa (1 bar)

WORKING TEMPERATURE

From -25° to + 110° C

COMPATIBILITY (ISO 2943)

Full with fluids: HH-HL-HM-HV-HTG
(according to ISO 6743/4)
For fluids different than the above
mentioned, please contact our Sales
Department.



APPLICATION EXAMPLE



STANDARD SERIES

FSC 31

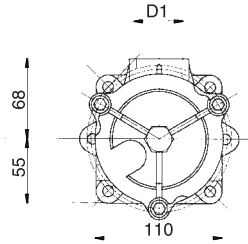
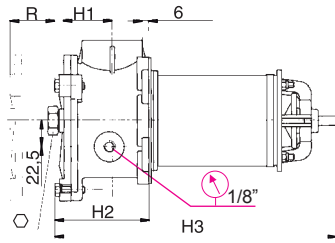

Tank mounting pattern

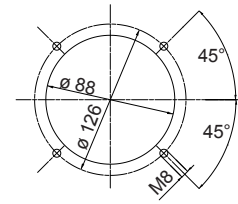

FSC 41

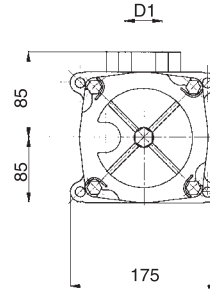
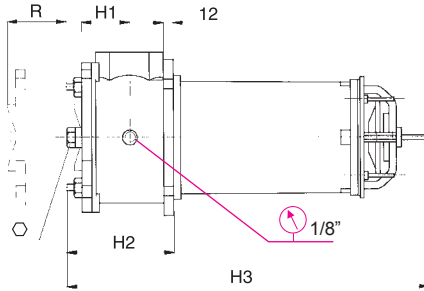

Tank mounting pattern

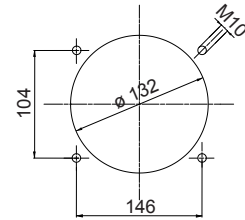

FSC 71

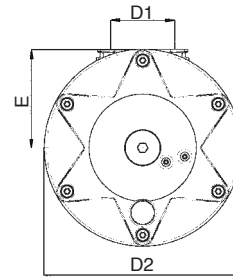
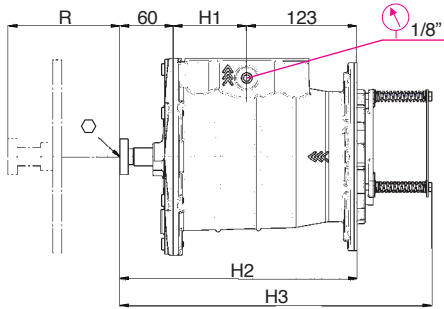

Tank mounting pattern

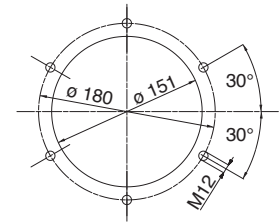

FSC 81

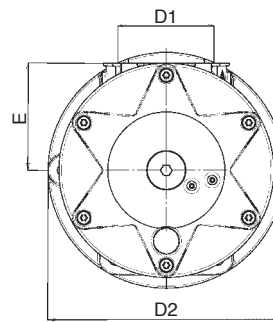
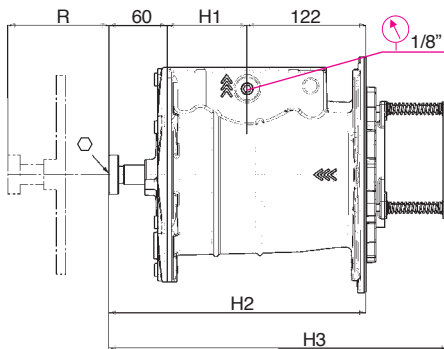

Tank mounting pattern

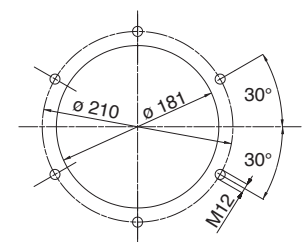

FILTER HOUSING

	D1	D2	E	H1	H2	H3	R	○	kg
FSC31	1" 1/4	-	-	42	80	275	250	22	1,6
FSC41	1" 1/2 - 2" - 2" 1/2	-	-	66	120	322	300	32	3,0
FSC71	3"	220	110	82	265	348,5	250	10	5,5
FSC81	4"	242	110	82	264	348,5	250	10	6,0

		TYPE						
		F = FILTER COMPLETE	F	F	F	F		
		B = FILTER HOUSING	B	B	B	B	ELEMENT	
S	C	FAMILY, NOMINAL SIZE & LENGTH				FAMILY SIZE & LENGTH		
		31	41	71	81		S C	
		PORT TYPE						
		B = BSP thread	B	B	-	-		
		F = SAE flange 3000 psi	-	F	F	F		
		PORT SIZE						
		10 = 1" 1/4 (B10 only)	10	-	-	-		
		12 = 1" 1/2 (B12 only)	-	12	-	-		
		16 = 2" (F16 only)	-	16	-	-		
		20 = 2" 1/2 (F20 only)	-	20	-	-		
		24 = 3"	-	-	24	-		
		32 = 4"	-	-	-	32		
W			BYPASS VALVE					
		W = without	W	W	W	W		
		SEALS				SEALS		
		N = NBR Nitrile	N	N	N	N	X = not applicable	
		F = FKM Fluoroelastomer	F	F	F	F	G = for water glycol	
		G = treatment for water-glycol	G	G	G	G		

		FILTER MEDIA				FILTER MEDIA	
		ME = metal wire mesh 60 μm	ME	ME	ME	ME	ME=w. mesh 60 μm
		MF = metal wire mesh 90 μm	MF	MF	MF	MF	MF= w. mesh 90 μm
		MG = metal wire mesh 250 μm	MG	MG	MG	MG	MG=w. mesh 250 μm

		CLOGGING INDICATOR				
		04 = nr. 2 x 1/8" seats, plugged	04	04	04	04
		10 = vacuum gauge, rear connection	10	10	10	10
		91 = SPDT, vacuum switch	91	91	91	91

		ACCESSORIES				
		W = without	W	W	W	W
		M = magnetic core	-	M	M	M

		ACCESSORIES				
		W = without	W	W	W	W
		S = safety microswitch	-	S	S	S

FILTER ELEMENT

	A	B	C	kg	Area (cm ²) Media M+
ESC31	29,5	70	163	0,25	1.600
ESC41	65	99	198	0,50	1.845
ESC71	77	120	196	0,80	2400
ESC81	93	136	196	0,90	2600

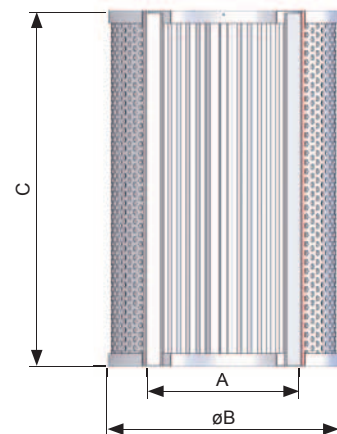

FLUID SPEED

when selecting the filter size, we suggest to consider also the max recommended fluid speed (in suction lines normally $0,1 < v < 1$ m/s)

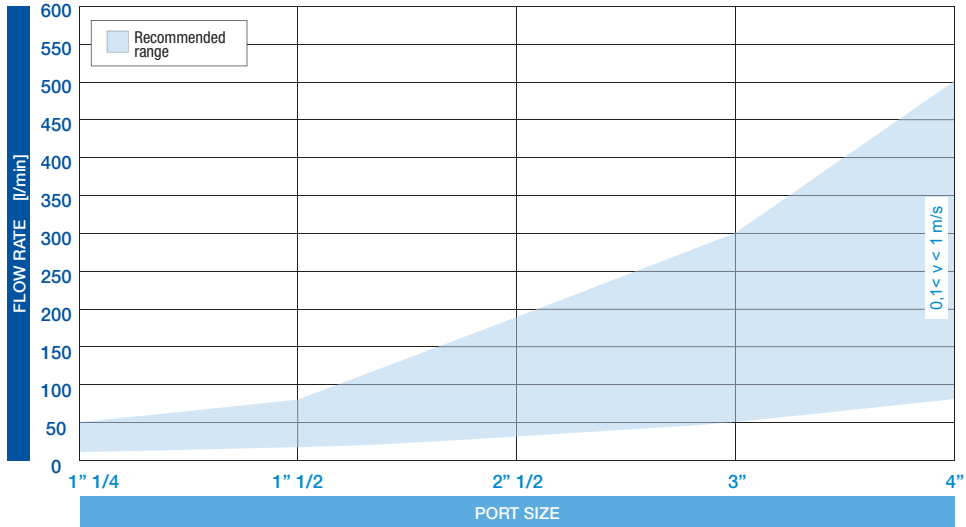

PRESSURE DROP CURVES (Δp)

The "Assembly Pressure Drop (Δp)" is obtained by adding the pressure drop values of the Filter Housing and of the Clean Filter Element corresponding to the considered Flow Rate and it must be lower than 3 kPa (0,03 bar).

FILTER HOUSING PRESSURE DROP
(mainly depending on the port size)

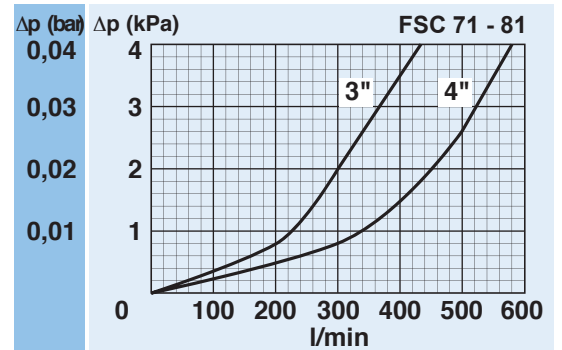
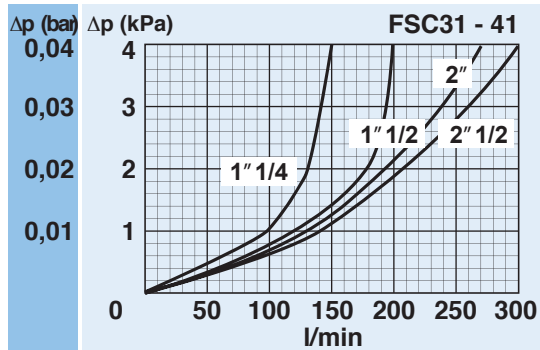

CLEAN FILTER ELEMENT PRESSURE DROP
(pressure drop values of the elements by ME - MF MG media are very similar)

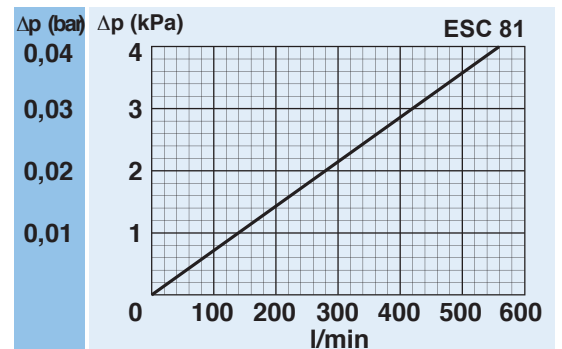
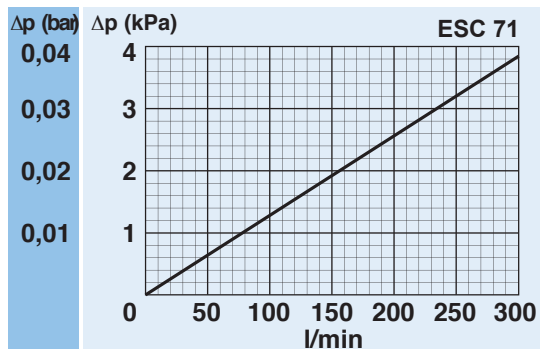
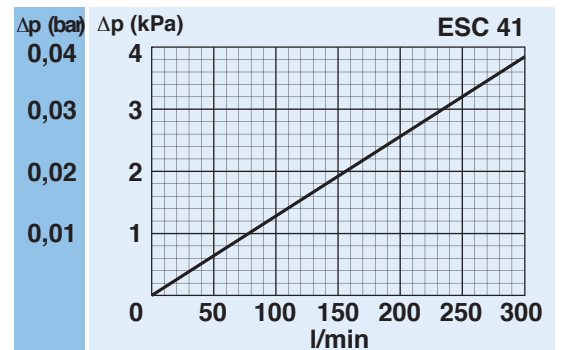
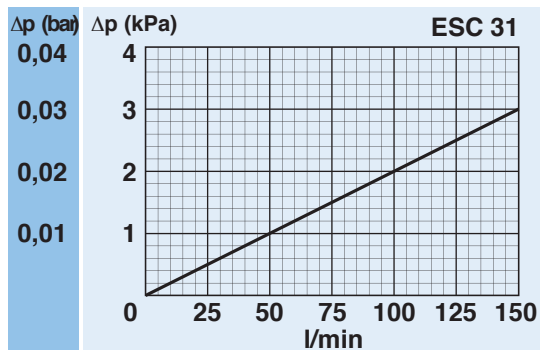

N.B. All the curves have been obtained with mineral oil having a kinematic viscosity 30 cSt and specific gravity 0,9 kg/dm³; for fluids with different features, please consider the factors described in the first part of this catalogue. All the curves are obtained from test done at the UFI HYDRAULIC DIVISION Laboratory, according to the specification ISO 3968:2005. In case of discrepancy, please check the contamination level, viscosity and features of the fluid in use.

CLOGGING INDICATOR

A visual or electrical indicator allows monitoring of the element condition. The port for the indicator is a standard feature.

MAGNETIC CORE

The optional magnetic core is an additional safeguard that pre-filters magnetic particles.

EASY MAINTENANCE

Operated by a hexagonal cover stud the shut-off valve isolates the tank oil allowing easy element replacement without emptying the reservoir.

FAST REPLACEMENT

Loosening four screws will allow removal of quick release cover and replacement element.

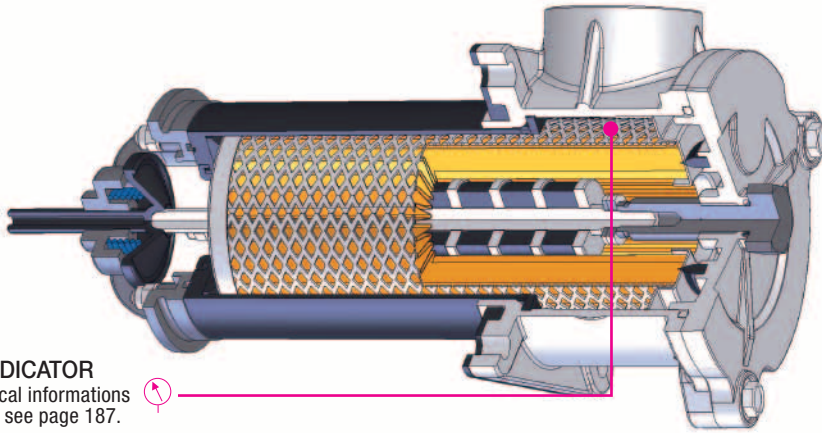

CLOGGING INDICATOR

For further technical informations and other options see page 187.





SERIES 10



SERIES 91

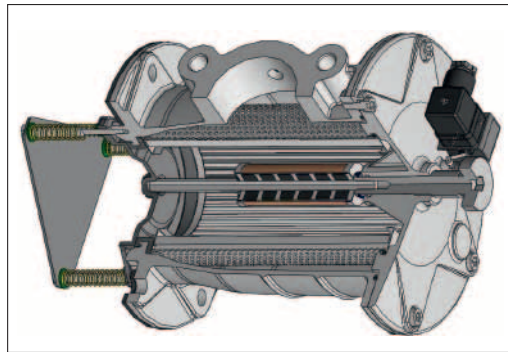



SAFETY MICROSWITCH

SPARE SEAL KIT

	NBR	FKM
FSC31	521.0088.2	521.0090.2
FSC41	521.0023.2	521.0091.2
FSC71	521.0097.2	521.0098.2
FSC81	521.0099.2	521.0100.2

SPARE PARTS ELEMENTS

(For filling up see table "Ordering and option chart")

FILTER HOUSING

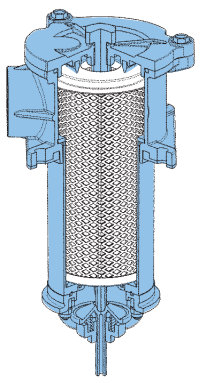

B | S | C | | | | W | | | | |

FILTER ELEMENT

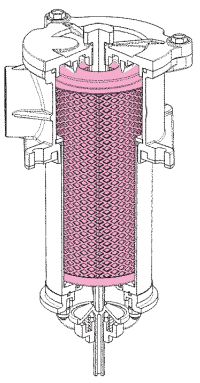

E | S | C | | | | | | | | |

CLOGGING INDICATOR

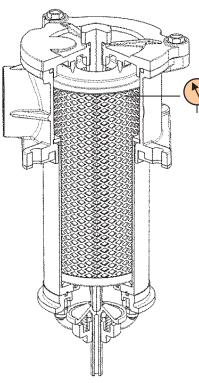

| |

ACCESSORY

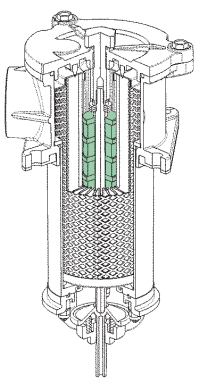

|

ACCESSORY

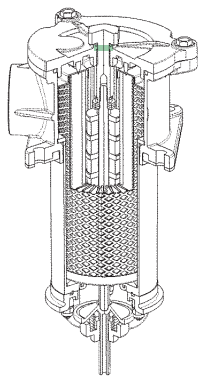

|

MAGNETIC CORE

SAFETY MICROSWITCH



Is this datasheet the latest release? Please check on our website.

